

产品特点 Product Features

- 无游离酸，电池可侧置90°安全使用。
 - 特殊板栅合金，配合优质的电解液，充分保证寿命。
 - 可靠的密封技术，使用安全可靠。
 - 严格的选材及先进的制造工艺，使自放电极小。
 - 配备防爆装置，确保安全性。
- No free acid battery can be safety used on its side position of 90°.
 - Special alloy of grid, superior electrolyte secures the battery life.
 - Reliable sealing technology, safe and reliable.
 - Strict selection of materials and advanced manufacturing technology, Low self-discharge.
 - Fitted with explosion proof filter, safety is guaranteed.

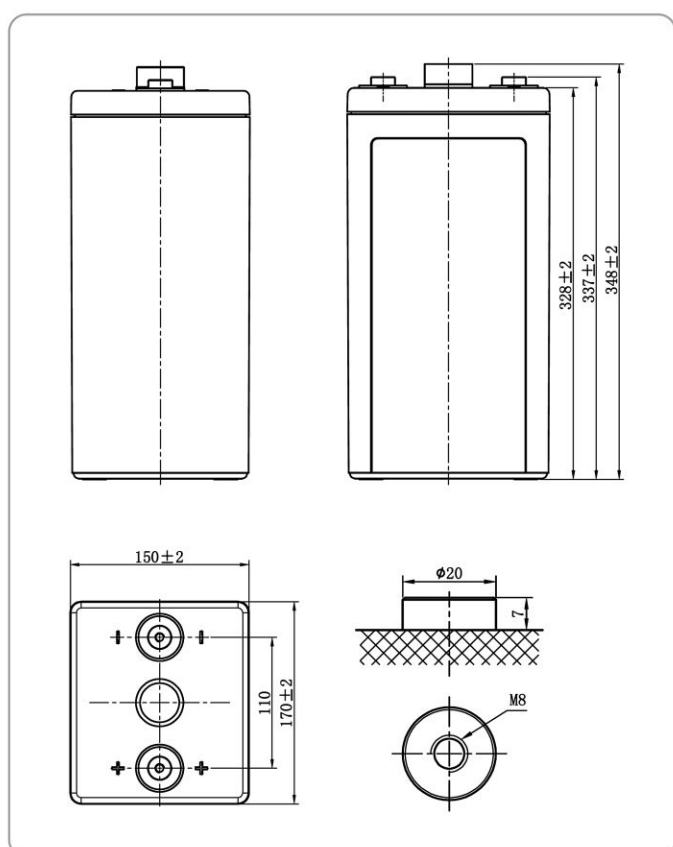

外形尺寸 Dimension (mm)



电池特征 Battery Characteristics

标称电压 Nominal Voltage	2V	
容量 Capacity (25°C)	C ₁₀ (30.0A,1.80V/cell)	300.0Ah
	C ₅ (78.0A,1.75V/cell)	234.0Ah
	C ₁ (184.0A,1.60V/cell)	184.0Ah
近似外形尺寸 Approd.Dimension	长 L	170 mm
	宽 W	150 mm
	高 H	328 mm
	总高 OH	348 mm
不同环境温度下的放置期限 Storage period at various temperature	20°C以下	9个月
	20°C ~ 30°C	6个月
	30°C ~ 40°C	3个月
重量 Weight	约18.8kg	
端子 Terminal	M8	
池壳材料 Container material	ABS	
内阻 (完全充电) IR, fully charged (25°C)	≤0.8 mΩ	
最大充电电流 Max.Charging Current (25°C)	90A	
充电方法 Charge method (25°C)	浮充 Float	2.25V/只
	均充 Equalization	2.30 ~ 2.40V/只
设计浮充寿命 Designed floating life	15年(25°C)	

广东汤浅蓄电池有限公司

YUASA BATTERY (GUANGDONG) CO., LTD.

限流恒压充电特性

Charge Characteristics at Constant Voltage with Limited Current

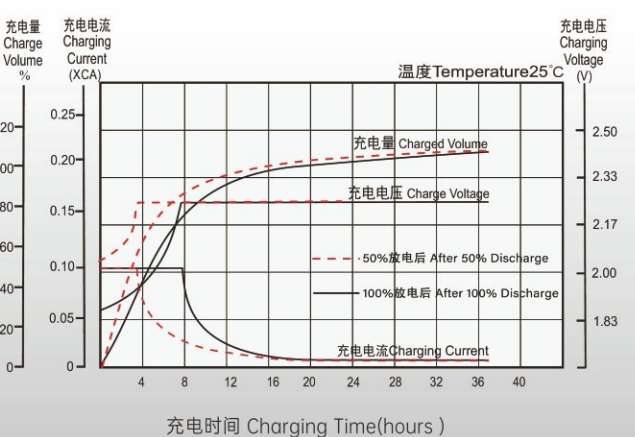

放电特性

Discharge Characteristics

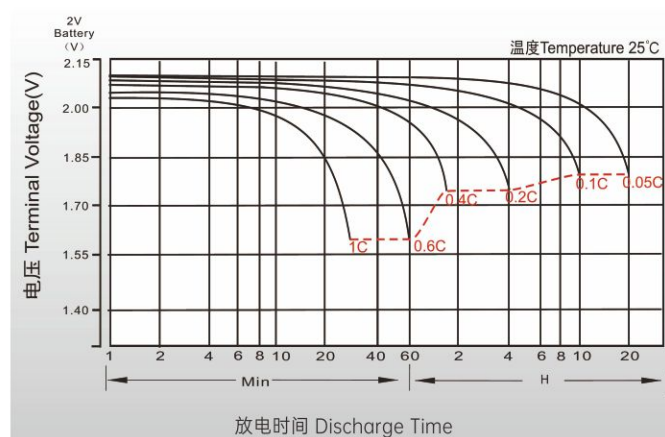

恒流放电表 Constant Current Discharge Characteristics (A, 25°C)

终止电压	30min	45min	1h	1.5h	2h	3h	4h	5h	6h	8h	10h	20h
1.80V	236.1	184.6	159.9	124.7	100.4	76.0	60.9	51.3	44.4	36.0	30.0	15.9
1.75V	246.7	192.1	165.8	128.9	103.5	78.0	62.4	52.5	45.3	36.7	30.5	16.1
1.70V	263.5	199.4	171.9	133.2	106.8	80.3	64.0	53.7	46.3	37.3	30.9	16.3
1.67V	272.1	203.9	175.5	135.6	108.6	81.5	64.9	54.4	46.8	37.7	31.2	16.4
1.60V	284.9	214.4	184.0	141.7	113.1	84.5	67.0	56.0	48.1	38.6	31.9	16.7

定功率放电表 Constant Wattage Discharge Characteristics (W/Cell, 25°C)

终止电压	30min	45min	1h	1.5h	2h	3h	4h	5h	6h	8h	10h	20h
1.80V	452.4	355.3	308.7	241.7	195.3	148.4	119.2	100.8	87.3	71.0	59.3	31.6
1.75V	468.9	366.9	317.9	248.3	200.2	151.7	121.7	102.7	88.9	72.1	60.1	32.0
1.70V	496.1	377.9	327.3	255.1	205.5	155.4	124.4	104.8	90.5	73.3	60.9	32.3
1.67V	507.4	384.4	332.5	258.8	208.2	157.3	125.8	105.8	91.5	73.9	61.4	32.6
1.60V	526.8	400.0	345.4	268.1	215.3	162.1	129.3	108.6	93.6	75.4	62.6	33.1

充电注意 Charging Recommendations

当温度偏离25°C时，请按每变化1°C，浮充使用按-3mV/单格进行修正，均充按-4mV/单格进行修正。

If the operating temperature varies significantly from the center value (25°C), temperature compensation for the charging voltage is recommended. The recommendation is -3mV/°C/cell for float use, and -4mV/°C/cell for equalization use.



杰士汤浅株式会社 GS YUASA CORPORATION
 广东汤浅蓄电池有限公司
 地址: 广东省佛山市顺德区大良飞鹅岗
 热线电话: 400-930-0628 传真: 0757-22635775
 电话: 0757-22620901 http://www.gdyuasa.com

认证标识 Approval indication



FM 45770 EMS 99952 OHS 750241